

Profilé porte-étiquette, profilé porte-lettre, profilé plastique et PVC rigide, semi-rigide

PERFILES PORTA-PRECIOS

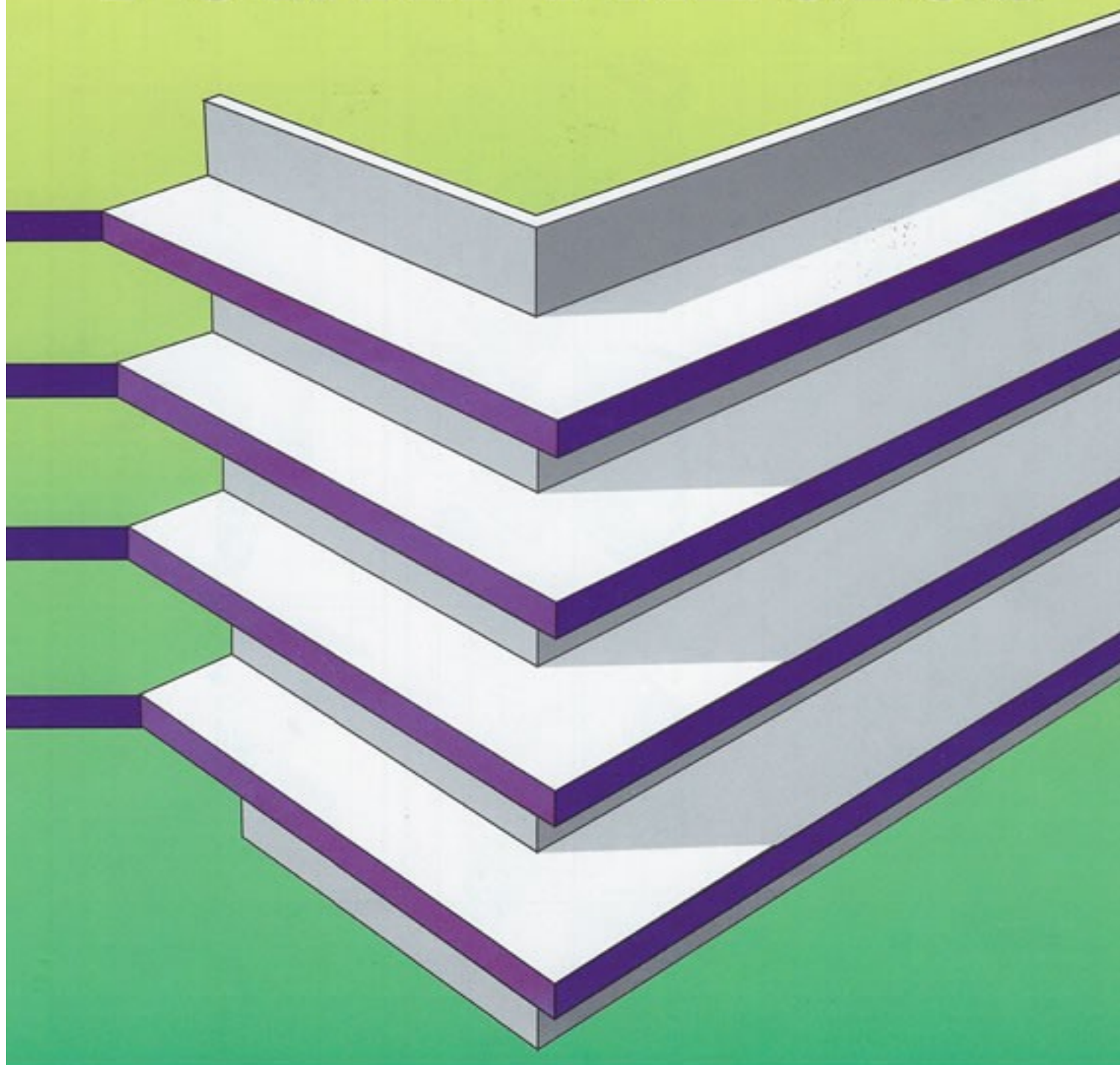
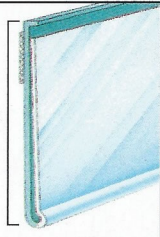
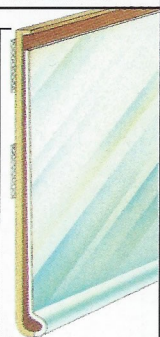
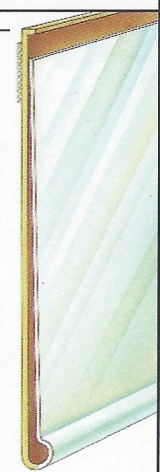
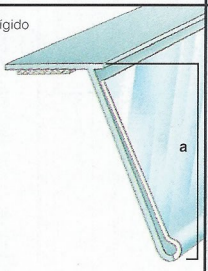
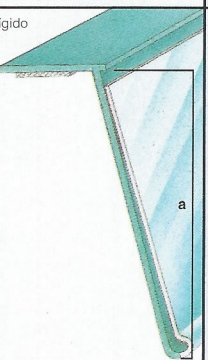

PERFILES PORTA-PRECIOS

MODELO	Ref.	Medidas A	B	Metros
Rígido  a	3558	30		4
BICOLOR CON ADHESIVO				
Rígido  a	2829	40		4
BICOLOR CON ADHESIVO				
Rígido  a	3560 3769	64 99		4
BICOLOR CON ADHESIVO				
Rígido  a	3557	30		4
BICOLOR CON ADHESIVO				
Rígido  a	3197	43		4
BICOLOR CON ADHESIVO				

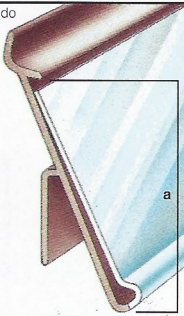
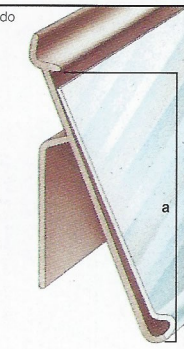
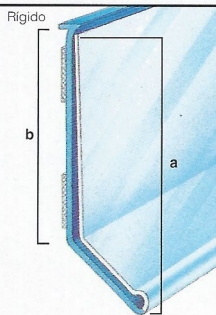
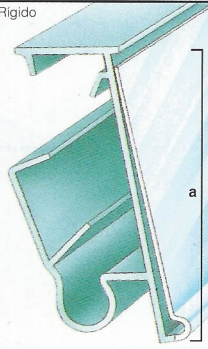
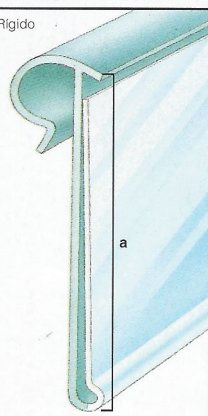

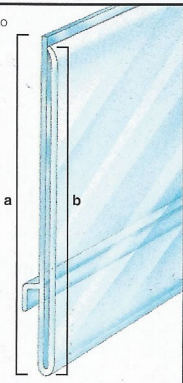
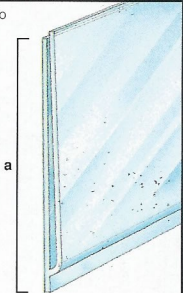
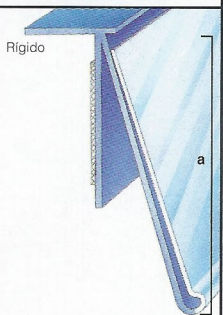
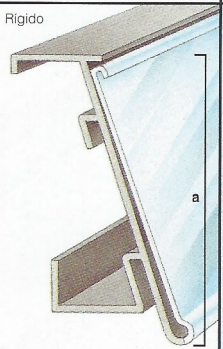
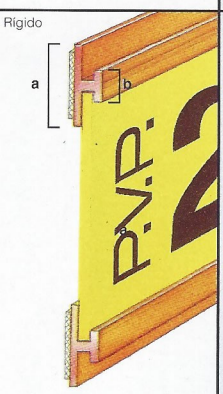
MODELO	Ref.	Medidas A	B	Metros
Rígido  a	3559	33		4
BICOLOR				
Rígido  a	3203	40		4
BICOLOR				
Rígido  b a	3698	40	30	4
BICOLOR CON ADHESIVO				
Rígido  a	3149	40		4
BICOLOR, DOBLE POSICION				
Rígido  a	3556	40		4
BICOLOR				

MODELO	Ref.	Medidas A	B	Metros
Rígido  a b	3509	44	43	4
TRANSPARENTE				
Rígido  a	3155	35		4
TRANSPARENTE				
Rígido  a	3561	43		4
BICOLOR CON ADHESIVO				
Rígido  a	3562	43		4
BICOLOR CON ADHESIVO				
Rígido  a b	3717	11	5	4
PORTA-PRECIOS GRADUABLE CON ADHESIVO				

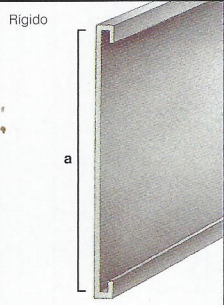
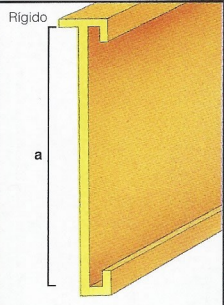
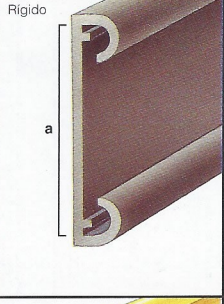
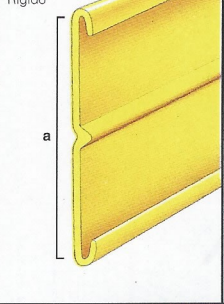
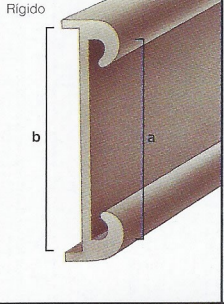
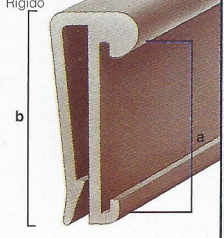
PERFILES PORTA-LETRAS

MODELO	Ref.	Medidas		Metros
		A	B	
Rígido 	1019 992 605 687 2130 2131	25 27 35 40 45 95		4
Rígido 	1049	40		4
Rígido 	1120 1220	21 30		4
Rígido 	359	32		4
Rígido 	1607	29	33	4
Rígido 	2999	23	30	4

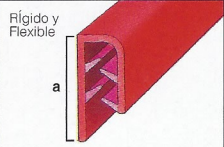
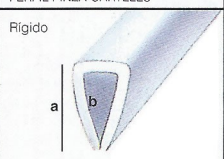
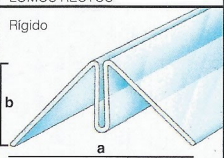
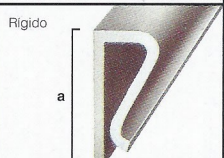
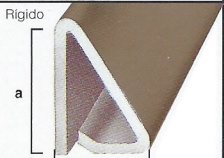
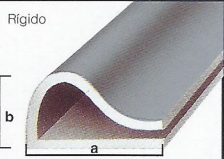
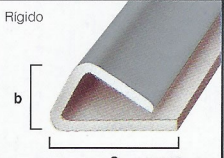
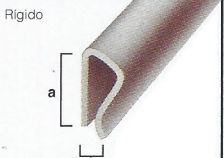
PERFILES PORTA-CARTELES

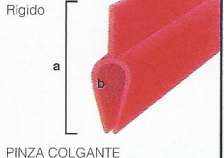
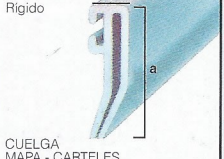
MODELO	Ref.	Medidas		Metros
		A	B	
Rígido y Flexible 	3707	15		4
PERFIL PINZA-CARTELES				
Rígido 	480 482 499 660 683	15 15 15 15 10	4 7 12 19 6	4
LOMOS RECTOS				
Rígido 	3447	86	40	4
TRANSPARENTE O COLORES				
Rígido 	1919 3409	26 20		4
PINZA MARCO				
Rígido 	Stilkrom EA-96	18	12	4
METALIZADO				
Rígido 	Stilkrom EA-94	17	10	4
METALIZADO				
Rígido 	Stilkrom EA-30 EA-33	17,5 17,5	10,5 12,5	4
METALIZADO				
Rígido 	1617	12	2,5	4
Rígido 	2555	14	23	4
PINZA COLGANTE				
Rígido 	2393	22	5	4
PINZA COLGANTE				
Rígido 	3241	20	5	4
CUELGA MAPA - CARTELES				

MARCOS PARA CARTELES

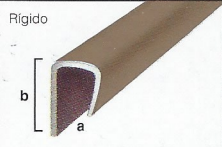
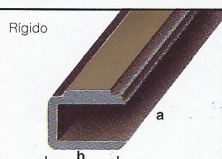
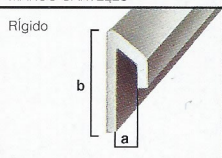
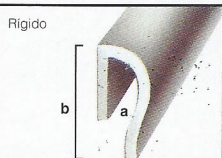
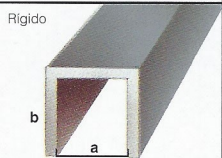
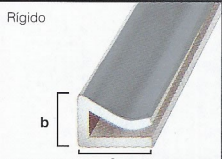
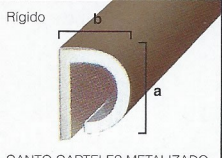
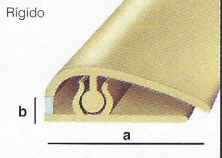
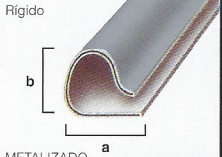
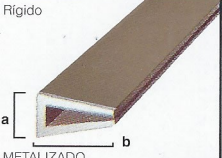
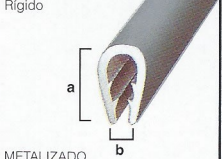
MODELO	Ref.	Medidas		Metros
		A	B	
Rígido 	Decoform 3304	4	11	4
MARCO CARTELES				
Rígido 	Decoform 2216	5	6	4
MARCO CARTELES				
Rígido 	1606	3	14	4
MARCO CARTELES				
Rígido 	1454	3	15	4
CANTO MARCO CARTELES				
Rígido 	Stilkrom 2047 2058 2069 2812 2114 2077	4 5 6 8 10 7	7 8 9 12 14 7	4
METALIZADO				
Rígido 	Stilkrom EA-77	9	6,5	4
METALIZADO				
Rígido 	Stilkrom 910 912 E-89 EA-25 EA-47	10 12 5 10 18	6 8 6 7 11	4
CANTO CARTELES METALIZADO				
Rígido 	3553	40	10	4
MARCO CON BISAGRA				
Rígido 	Stilkrom EA-92	12	10	4
METALIZADO				
Rígido 	Stilkrom E-25 E-30 EA-29	5 8,5 6,5	10 7,5 9	4
METALIZADO				
Rígido 	Stilkrom 3035 3047 3059 3610 3819	5 7 9 10 19	3 4 5 6 8	25
METALIZADO				