

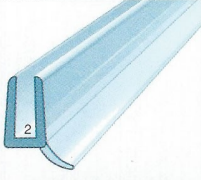
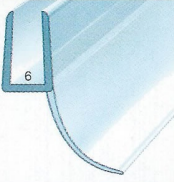
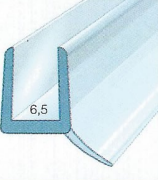
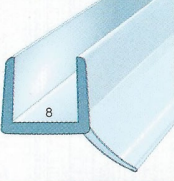
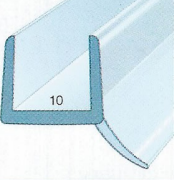
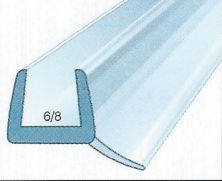
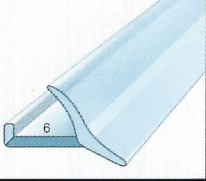
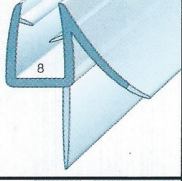
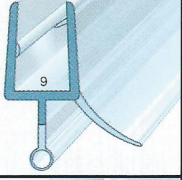
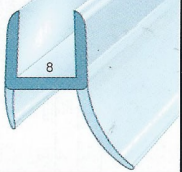
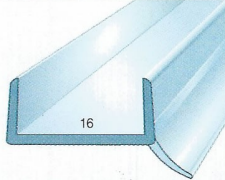
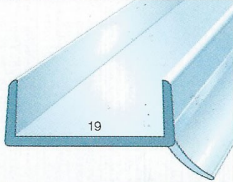
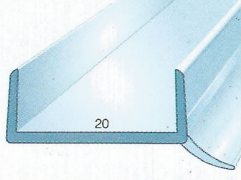
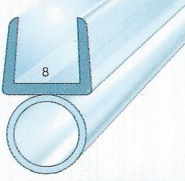
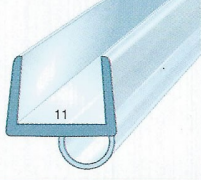
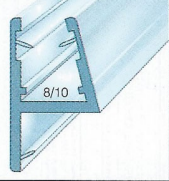
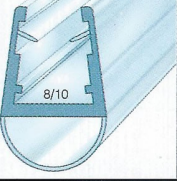
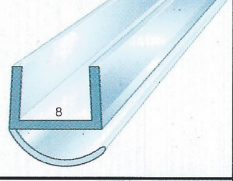
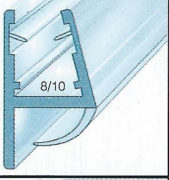

DURIGOM

PERFILES-JUNTAS DE DOBLE DUREZA

TANAS, MAMPARAS, CABINAS, VITRINAS, MÓDULOS, VEST

MODELO
 2160
*  3921
 3216
 3185/8
 3185/10
 4168
*  4160
*  4093
*  4167
 2642



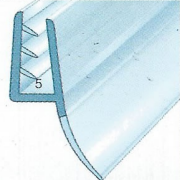
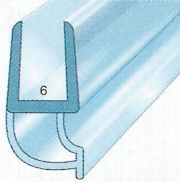
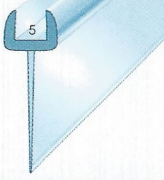
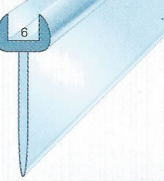
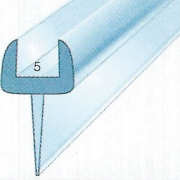
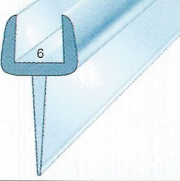
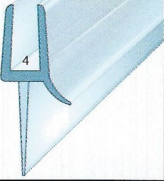
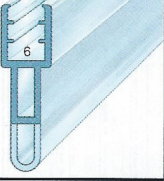
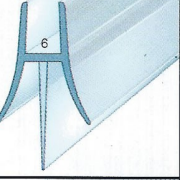
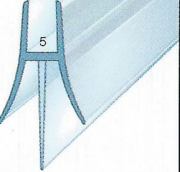

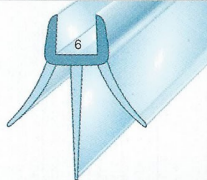
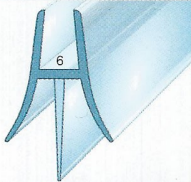
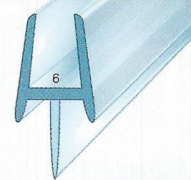
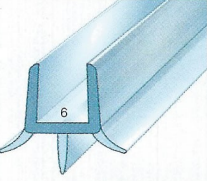
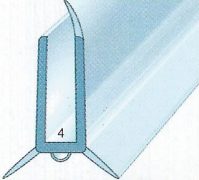
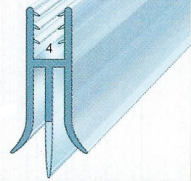
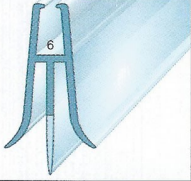
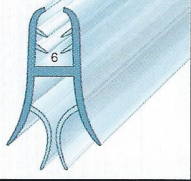
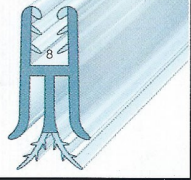
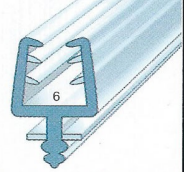
MODELO
 1930
 3250
 3678
 2778
 3082
*  4153
 4142
*  4145
*  4152
*  4144

MODELO
 3533
*  3588
 3415/5
 3415/6
 3194/5
 3194/6
 3202
 4004
 3876
 3808

MODELO
*  3754
 3195
 3196
 3702
 3199
 3997
*  3933
*  3460
 3193
*  3511

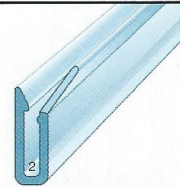
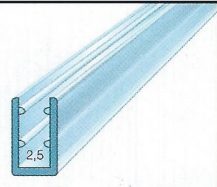
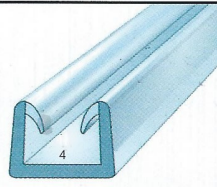
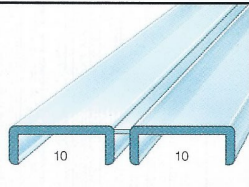
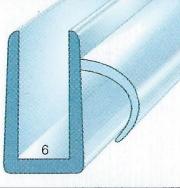
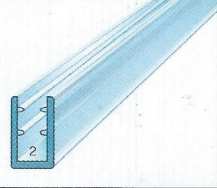
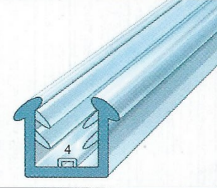
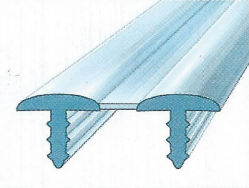
 Material Rígido
 Material Flexible

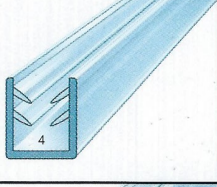
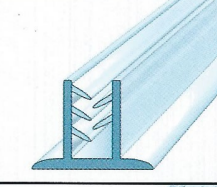
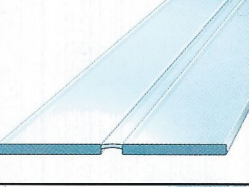
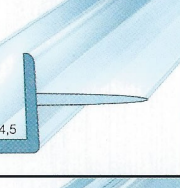
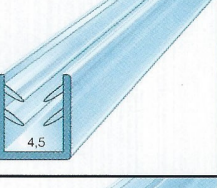
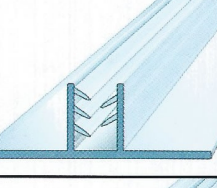
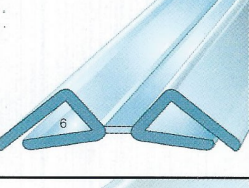
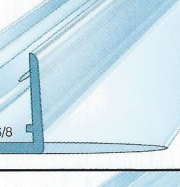
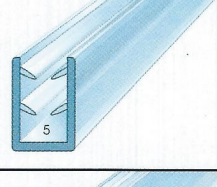
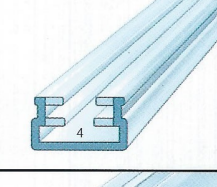
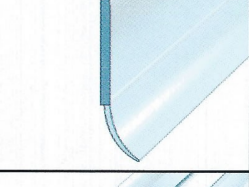
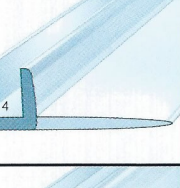
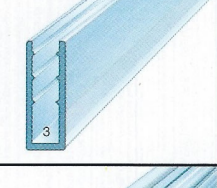
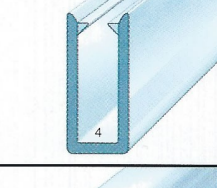
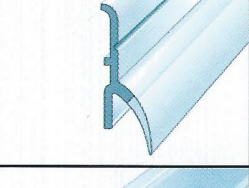
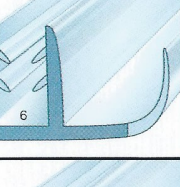
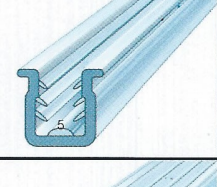
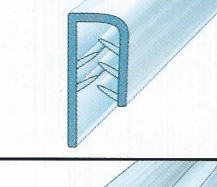
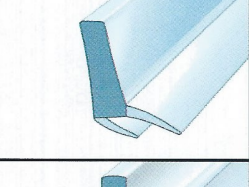
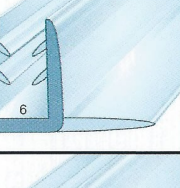
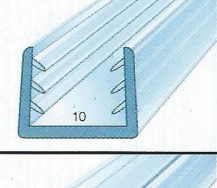
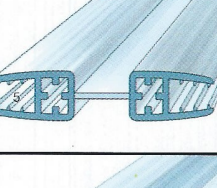
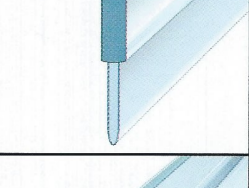
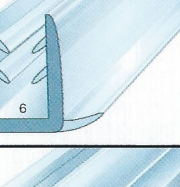
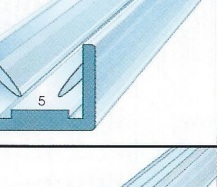
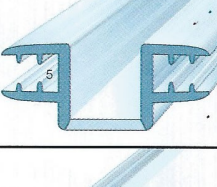
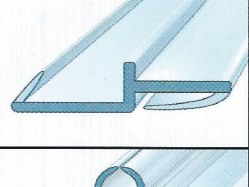
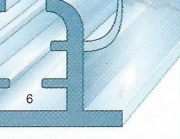
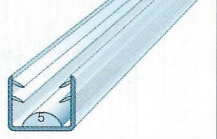
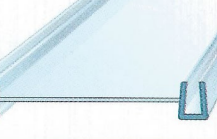
* Exclusivos de clientes.

MODELO	MODELO	MODELO	MODELO
4225 	4226 	4235 	3264 
* 3766 	3633 	4182 	2170/10 
* 3269 	4137 	3956 	3000 
* 3481 	4025 	4082 	4172 
* 4092 	3711 	3912 	* 3110 
* 3805 	4227 	2953 	* 2120 
4087 	4228 	3707 	2714 
4086 	* 4107 	* 3660 	1200 
4085 	* 4165 	* 3512 	3942 
* 3482 	4177 	4100 	3817 

 Material Rígido
 Material Flexible

* Exclusivos de clientes.

MODELO	MODELO	MODELO	MODELO
* 3781	3162/16	3508	2706
* 3953	4136/16	2898	2190
* 3191	* 3577	3098	3279
3041	* 3620	3056	3058
* 3589	* 4135	3057	4033
3503	3513	2794	3042
3665	3034	2110	3599
1920	2020	4044	3579
4217	3469	3911	3061
3638	2906	2722	* 3586

 Material Rígido
 Material Flexible

* Exclusivos de clientes.

MODELO	MODELO	MODELO	MODELO
3449	3050	4229	
3913	2930	3074	
4084	3059	* 3661	
3721	* 3497	* 3777	
3722	4009	4000	
3723	2594	4066	
2938	1970	4069	
3432	3152	3949	
3734	* 3632	4122	
2954	3676		

 Material Rígido
 Material Flexible

* Exclusivos de clientes.

Pour tous renseignements, contactez Rhonalpex au : 0 37 85 84 00 ou formulaire de contact du site